

Supplied in case of damage to  
Bumper Feet on models  
752, 753 & 754 only

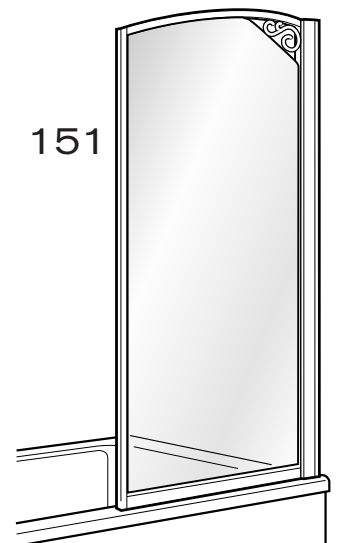

SIDE PANEL	WIDTH EXTENDED	WIDTH FOLDED
151	800mm	-
751	800mm	-
752	960mm	525mm
753	1400mm	525mm
754	803mm	275mm

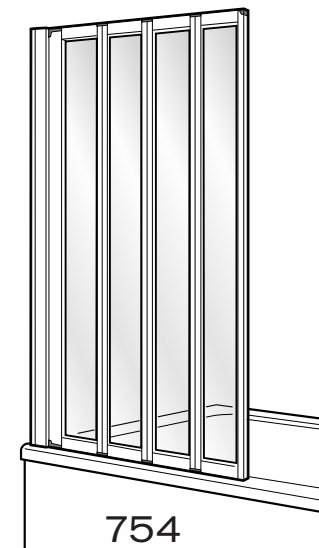
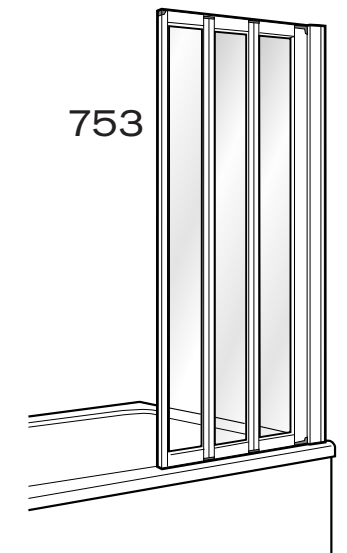
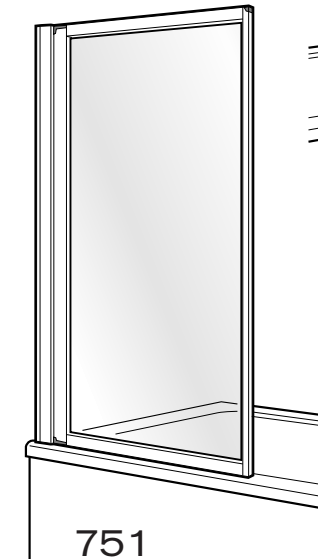
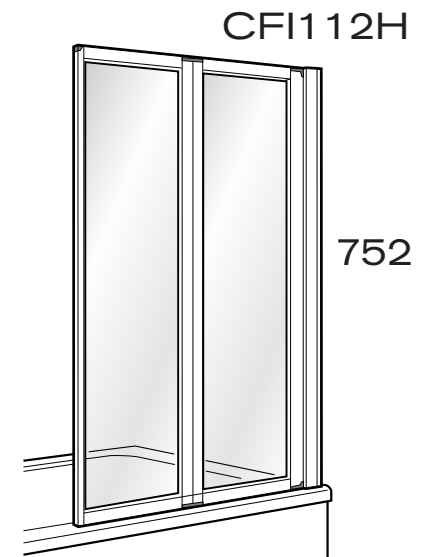
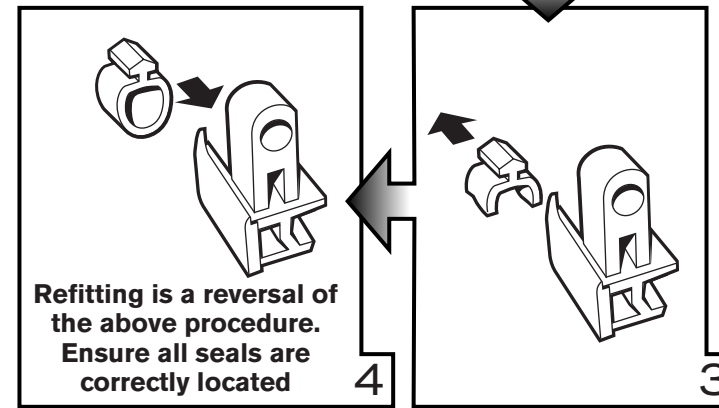
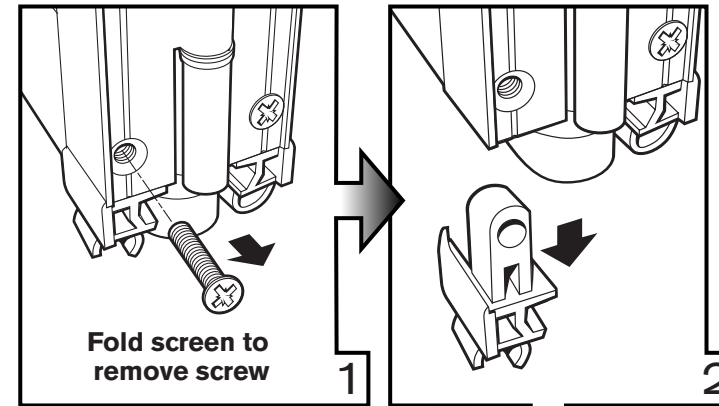
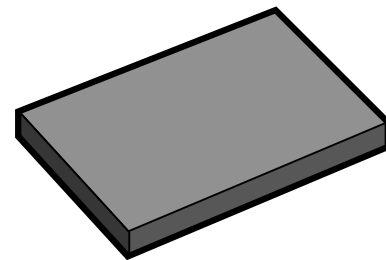
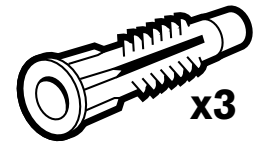
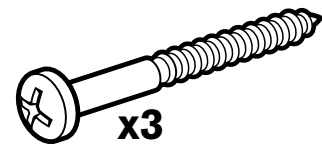

**RECOMMENDED SAFETY PRECAUTIONS**



Protective footwear  
when lifting panels

Safety glasses  
when drilling

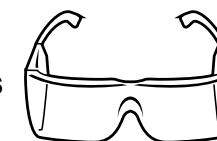

**44 (0)151 606 5000**

**Bath screens**  
(151, 751, 752, 753, 754)

Daryl Industries Limited  
Alfred Road, Wallasey, Wirral, CH44 7HY England  
Tel 44 (0)151 606 5000 Fax 44 (0)151 638 0303  
www.daryl-showers.co.uk  
E-mail Daryl@daryl-showers.co.uk

